

Victor Products Ltd  
 Unit 3A, Tyne Dock East Side  
 Port of Tyne,  
 South Shields,  
 Tyne and Wear  
 NE33 5SQ  
 United Kingdom  
 Tel : +44(0)191 2808000  
 Fax : +44(0)191 2808080





## Making Hazardous Environments Work

### TYPE A44SCR RESTRAINED 100AMP 650/1300V FLP COUPLER SOCKETS

**Certification number Baseefa02ATEX0080U I M2 EExd I**

#### NAMEPLATE DETAIL

	Victor Products Ltd. Newcastle upon Tyne 2813 NE27 0QF United Kingdom	TO LOAD 
	TYPE A44SCR <b>Baseefa02ATEX0080U</b> I M2 EExd I	
100A 650/1300V BS5125		
SERIAL NO.		
FOR USE WITH ELECTRICAL INTERLOCK		
DO NOT SEPARATE WHEN ENERGISED		

#### General

These coupler sockets are designed in accordance with EN50014:1997 and EN50018:2000. They can be associated with any relevant certified connectors for flameproof enclosures Group I apparatus that complies dimensionally with BS5125.

#### Installation - all

1. Installation, maintenance, and inspection, must be carried out by suitably qualified personnel in accordance with established codes of practice.
2. Restrained types of coupler sockets are for use with electrical interlock.
3. Ensure that the rated voltage and current are compatible with the power supply and load requirements. It should be note that when connected to systems of lower voltages or current, the lower rating shall apply.
4. The plugs are designed to accept cables from 22mm to 52mm diameter. Ensure that the size of the cable being used is compatible with the sealing ring diameter fitted within the plug.

## Installation – Screened and/or P.W.A. Cables

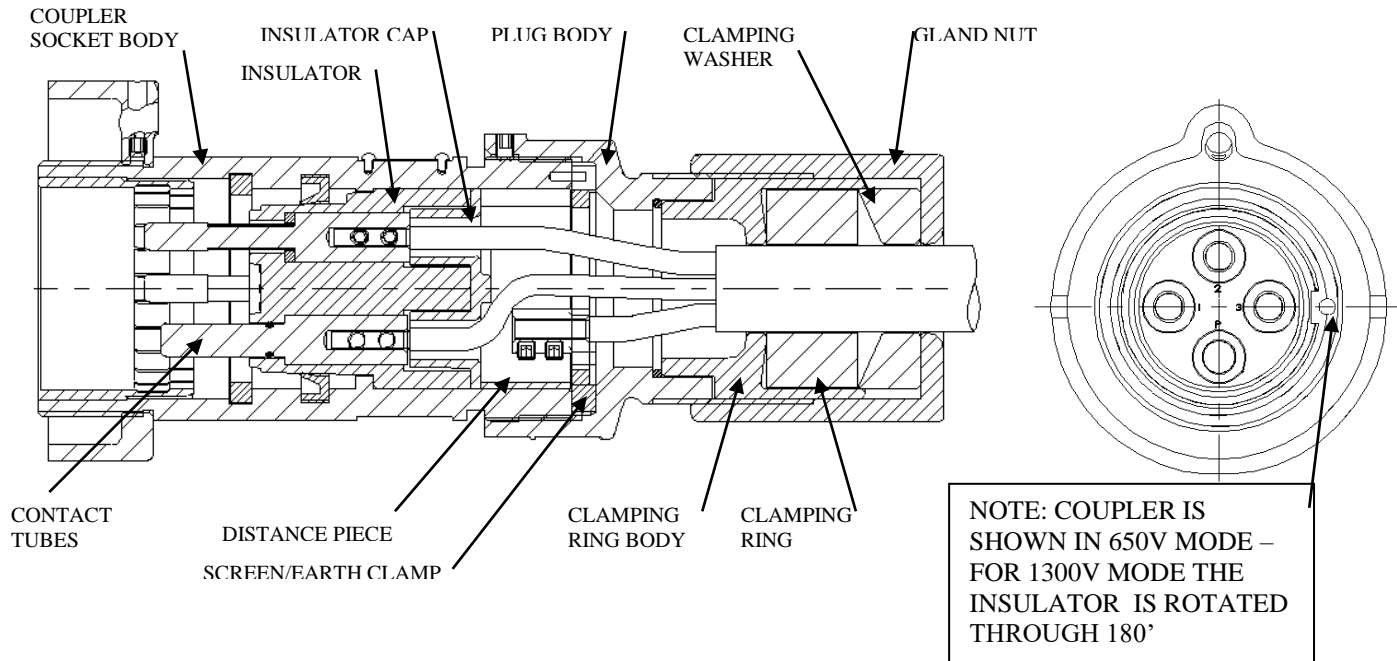

**Fig.1 RESTRAINED COUPLER SOCKET FOR SCREENED CABLE**

**NOTE A:** For types designed for use with screened and/or P.W.A. cable, there will be armour cable clamps, and a longer plug body will be used – see Fig. 2 below:

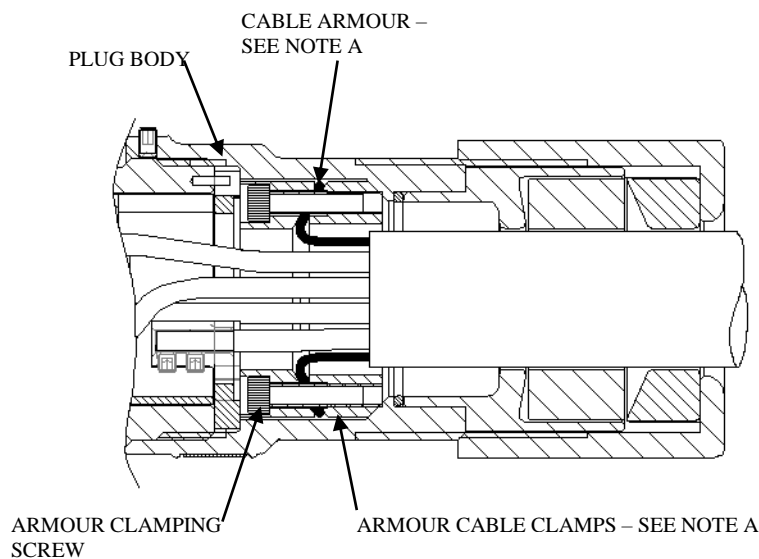

**Fig. 2 RESTRAINED COUPLER SOCKET FOR SCREENED AND P.W.A. CABLE**

1. Feed Gland Nut, Clamping Washer, Clamping Ring, Clamping Ring Body, and Plug Body along the cable in that order.
2. The cable should now be stripped in accordance with the appropriate diagram ( Fig.3 ). Baring of the power and pilot cores should be left until stage 6. The screens should be carefully twisted together ensuring that the maximum screen covering is maintained between the cores.
3. **(GO STRAIGHT TO STAGE 5 IF CABLE IS NOT P.W.A.)** Place the armour clamp seat over cable up to the end of the outer sheathing. Bend back the armour wires as equally spaced as possible over tapered surface of seat without covering the tapped holes. Cut off inner sheathing or cradle level with the clamp seat.

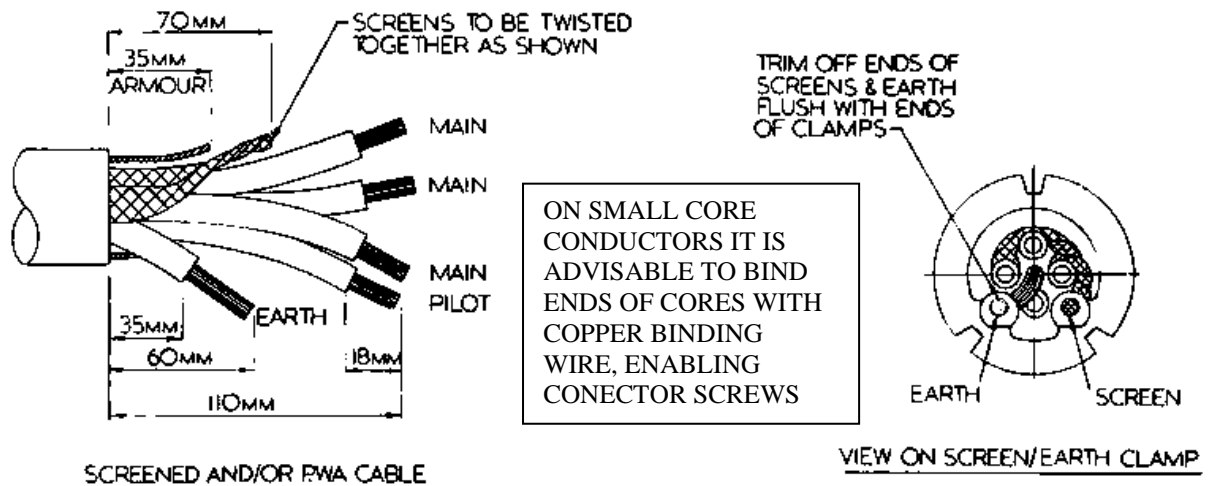

Fig.3

4. Place the armour clamp over cable and firmly secure armour wire by tightening the socket head clamping screws. Trim off the armour wire flush with the diameter of the clamps.
5. Twist the screens together and pass through one boss on the earth/screen clamp, feed the earth core into the other boss. Push the earth/screen clamp against the armour clamps (or plug body if cable is not P.W.A.) and tighten the grub screws onto screens and earth core. Trim off the ends flush with the clamping bosses.
6. Place insulator cap over mains and pilot leads and secure mains and pilot contact tubes with grub screws. Large size cores can be sweated if preferred. Fit distance piece between earth/screen clamp & insulator cap. Fit insulator, heads of grub screws slide down keyways in holes. Ensure pilot contact enters correct hole.
7. Fit coupler socket body assembly over insulator taking care to locate front end of insulator on peg in barrel. Screw plug body onto the coupler socket body, and secure socket set screw. The gland nut can now be tightened onto the plug body to compress the clamping washer & clamping ring, and seal and secure the outer sheath.

### Maintenance and Inspection

It should be noted that all components that are replaced must be supplied by the original manufacturer. Failure to use such components invalidates the certification and approval and may make the apparatus dangerous. NO modifications should be made to the apparatus without the knowledge and approval of the manufacturer. If in doubt, refer to the manufacturer. A copy of the Spare Parts List is available from Victor Products Ltd.

Before re-assembly ensure that all flameproof paths are visually inspected and dimensionally checked for any abnormality.

### HEALTH AND SAFETY AT WORK etc. ACT 1974

In the United Kingdom all equipment must be installed, operated and disposed of (as required) within the legislative requirements of the Health and Safety at Work etc. Act 1974. Leaflet No. HSS L1 refers to the Company's obligation and is available on request.

It is the responsibility of the user to select, install, operate and maintain the equipment in accordance with the relevant legislation and appropriate code of practice.



**EU Only**

Prices and design are subject to alteration without notice. All products are sold subject to our conditions of sale, copies of which are available on request.

*We reserve the right to change characteristics of our products. All data is for guidance only*

# Attestation of Conformity

Attestation de Conformité  
Konformitätsbescheinigung



Victor Products Ltd<sup>®</sup>  
Unit 3A, Tyne Dock East Side  
Port of Tyne,  
South Shields,  
Tyne and Wear  
NE33 5SQ  
United Kingdom

## TYPE A44SCR RESTRAINED 100AMP 650/1300V FLP COUPLER SOCKETS

**Certification number Baseefa02ATEX0080U I M2 EExd I**

### Victor Products Ltd

**Hereby declare our sole responsibility that the product which is the subject of this attestation is in conformity with the following standards or normative documents.**

Erklären in alleiniger Verantwortung, daß das Product auf das sich diese Bescheinigung bezieht, mit der/den folgenden Norm(en) oder normativen Dokumenten Ubereinstimmt.

Déclarons de notre seule responsabilité, que le produit auquel cette attestation se rapporte, est conforme aux norme(s) ou aux documents normatifs suivants.

<b>Number and date of standard</b> Nr. Sowie Ausgabedatum der Norm No. Ainsi que date d'émission des normes.	<b>Directive description</b> Bestimmungen der Richtlinie Prescription de la directive
EN 50014 (1998) EN 50018 (2000) This equipment has been reviewed against the requirements of EN60079-0: 2018 and EN60079-1: 2014, in respect of the differences from the standards to which this certificate was issued; none of these differences affect this equipment.  Dieses Gerät wurde hinsichtlich der Unterschiede zu den Standards, für die dieses Zertifikat ausgestellt wurde, mit den Anforderungen von EN60079-0: 2018 und EN60079-1: 2014 verglichen. Keiner dieser Unterschiede wirkt sich auf dieses Gerät aus.  Cet équipement a été passé en revue contre les conditions d'EN60079-0 : 2018 et EN60079-1 : 2014, en ce qui concerne les différences des normes auxquelles ce certificat a été délivré ; aucune de ces différences n'affecte cet équipement.	<b>Equipment and protective systems intended for use in potentially explosive atmospheres.</b> This Attestation is valid for directive 2014/34/EU.  Geräte und Schutzsysteme zur bestimmungsgemäßen Verwendung in explosionsgefährdeten Bereichen. Diese Bescheinigung gilt für die Richtlinie 2014/34 /EU.  Appareils et systèmes de protection destinés à être utilisés en atmosphères explosibles. Cette Attestation est valable pour la directive 2014/34 /UE.
EN50082 (1992) EN55015 (1993) EN 60555-2 (1987)	<b>89/336 EEC: Electromagnetic Compatability</b>  89/336 EWG: Elektromagnetische Verträglichkeit  89/336 CEE: Compatibilité électromagnétique
<b>Notified Body:</b> CSA Group Netherlands B.V. Notified Body No. 2813	  P. Devlin Operations Manager January 2024

SERIAL NUMBER